

VON DUPRIN®

Installation Instructions

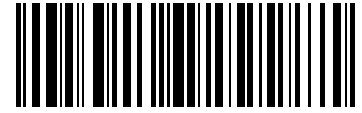

931232-00

STRIKEFORCE® 6112/6112DS Electric Strike

Single Door Rim Application



Note: Check with factory for retrofit applications.

1. For lock or device preparation, see their directions. Also see application schedule on other side.
2. Prepare frame for strike (see other side).
3. Wire strike (Figure 1). (Switches on 6112DS only.)

4. Test strike: Apply solenoid power. Fail secure (FSE) lip unlocks. Fail safe (FS) lip locks. Figure 1 shows status of switches.
5. Install strike with two #12-24 screws. Make sure clearance between latch bolt and strike lip is 1/32" (Figure 2).
6. If latch bolt does not extend far enough to actuate tripper, install extension (Figure 3). (Tripper on 6112DS only.)
7. Test door: With strike unlocked, door opens with latch bolt extended. When door closes, latch bolt rides over strike lip.

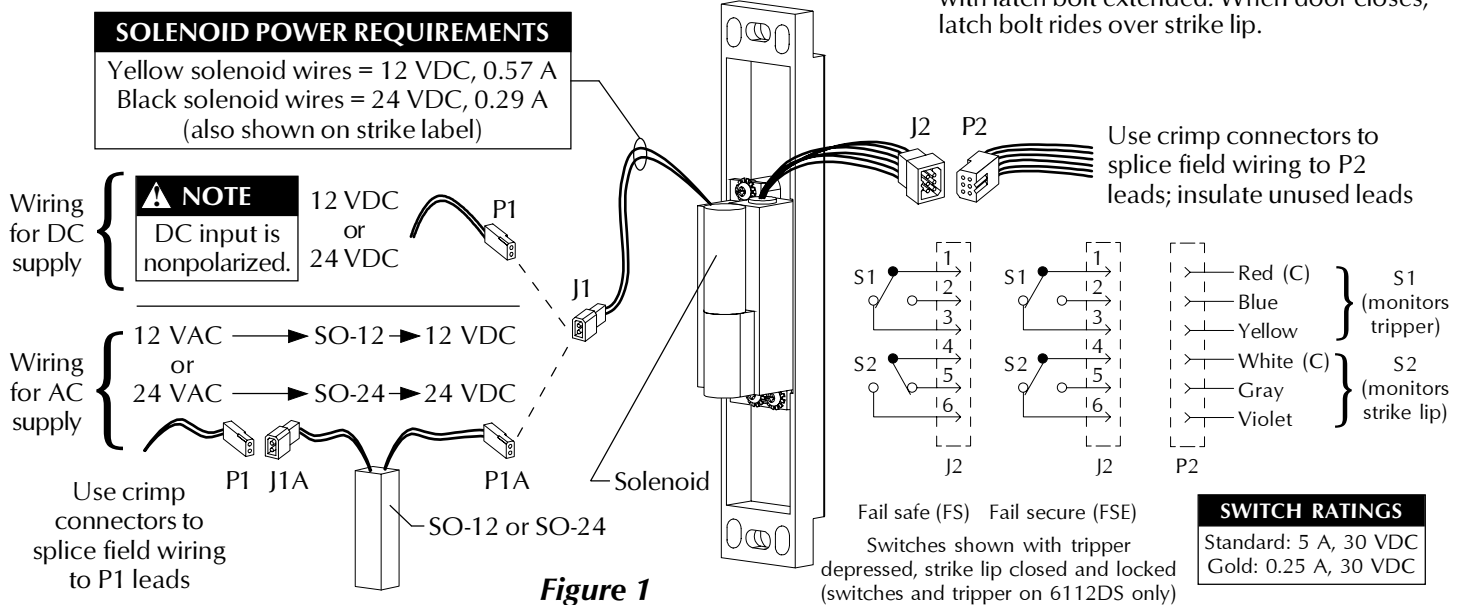

Figure 1

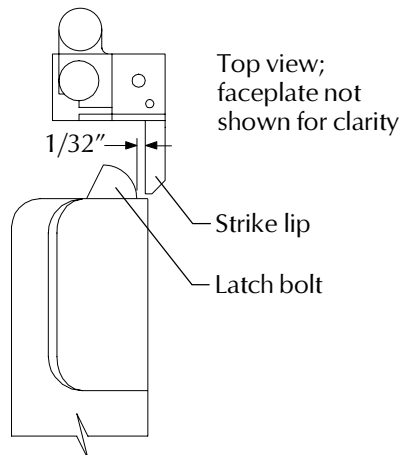

Figure 2

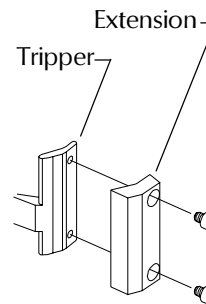
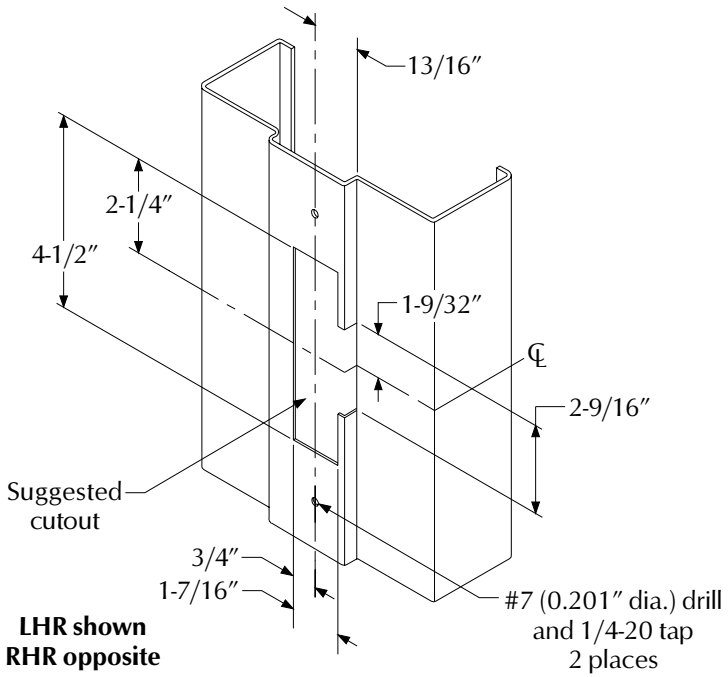
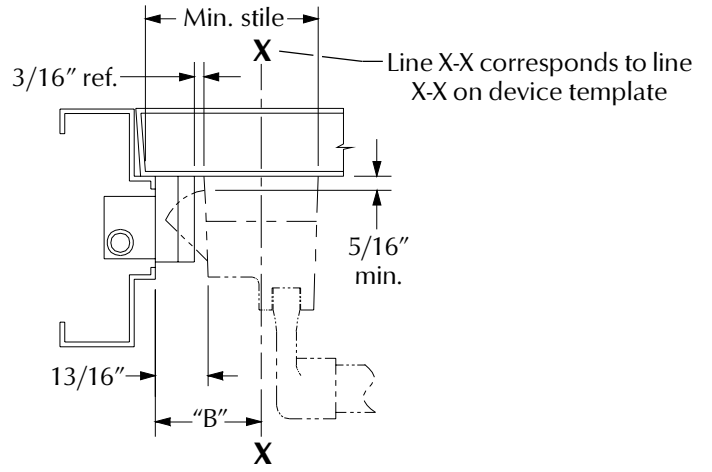

Figure 3



Frame Preparation for Strike



Device	"B"
22 Rim and 98/99 Rim	2-7/16"
33/35 Rim EO/DT/NL/TP	1-13/32"
33A/35A Series Rim	1-15/32"
88 Rim EO/DT/NL/TP	2-1/2"
88 Rim K	2-3/8"
For other devices, consult factory.	

Application Schedule

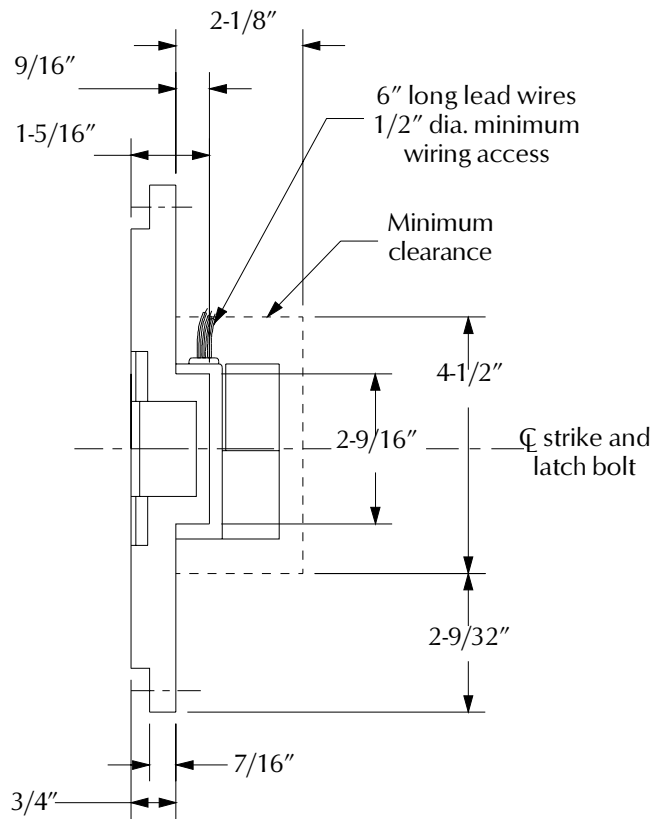
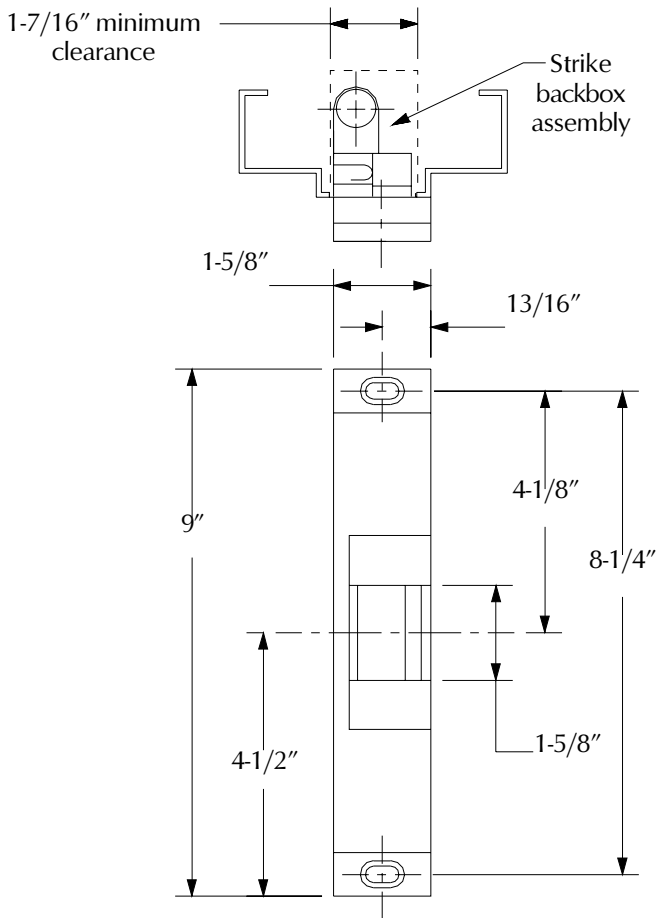

Strike Dimensions and Required Clearances